

KATALOG 22

PE 100 RØR • PE 100 FITTINGS

Klik på tekst eller billede for at gå direkte til den ønskede side:

<p>PE 100 svejserør</p>  <p>22-2</p>	<p>Elektromuffe</p>  <p>22-3</p>	<p>Elektrovinkel</p>  <p>22-3</p>	<p>Elektro tee</p>  <p>22-4</p>
<p>Elektro reduktion</p>  <p>22-5</p>	<p>Overgang PE-spids x messing nippel</p>  <p>22-5</p>	<p>Overgang PE-spids x messing muffe</p>  <p>22-6</p>	<p>Lang bøjning</p>  <p>22-6</p>
<p>Lang bøjning støbt</p>  <p>22-9</p>	<p>Lang vinkel støbt</p>  <p>22-10</p>	<p>Lang tee</p>  <p>22-11</p>	<p>Grenrør lang</p>  <p>22-12</p>
<p>Reduktion lang</p>  <p>22-12</p>	<p>Endekappe</p>  <p>22-14</p>	<p>Flangehale</p>  <p>22-14</p>	<p>Bøjning kort</p>  <p>22-15</p>
<p>Vinkel kort</p>  <p>22-15</p>	<p>Tee kort</p>  <p>22-16</p>	<p>Reduktion kort</p>  <p>22-17</p>	<p>PP belagt stålflange</p>  <p>22-18</p>

PE FITTINGS • PE 100 SVEJSERØR

KATALOG 22

Tekniske informationer

Materiale:

Polyethylen PE100 MRS10

Kompabilitet:

Kan sammensvejses med PE materialer med **Melt Flow Index MFI** 190%/5 kg mellem 0,2 og 1,3gr/10min.

Det betyder at næsten alle rør, fittings og ventiler fremstillet af PE63, PE80 og PE100 kan svejses sammen

Trykbelastning (vand):

	PN	SDR
PE80	20	7,4
	16	9
	10	11
	6	17
	4	27,6
	3,2	33

	PN	SDR
PE100	25	7,4
	20	9
	16	11
	10	17
	6	26
	4	33

PE 100 svejserør



Varenr,	Beskrivelse
103906110	110 x 4,3 mm - PN6
103906125	125 x 4,8 mm - PN6
103906140	140 x 5,4 mm - PN6
103906160	160 x 6,2 mm - PN6
103906180	180 x 6,9 mm - PN6,3
103906200	200 x 7,7 mm - PN6
103906225	225 x 8,6 mm - PN6
103906315	315 x 12,1 mm - PN6
103910032	32 x 2,4 mm - PN10
103910040	40 x 2,4 mm - PN10
103910050	50 x 4,0 mm - PN10
103910063	63 x 3,8 mm - PN10
103910075	75 x 4,5 mm - PN10
103910090	90 x 5,4 mm - PN10
103910110	110 x 6,6 mm - PN10
103910125	125 x 7,4 mm - PN10
103910140	140 x 8,3 mm - PN10
103910160	160 x 9,5 mm - PN10
103910180	180 x 10,7 mm - PN10
103910200	200 x 11,9 mm - PN10
103910225	225 x 13,4 mm - PN10
103910250	250 x 14,8 mm - PN10
103910315	315 x 18,7 mm - PN10
103910355	355 x 21,1 mm - PN10
103910400	400 x 23,7 mm - PN10
103916090	90 x 8,2 mm - PN16
103916110	110 x 10,0 mm - PN16
103916140	140 x 12,7 mm - PN16
103916160	160 x 14,6 mm - PN16
103916200	200 x 18,2 mm - PN16
103916225	225 x 20,5 mm - PN16
103916250	250 x 22,7 mm - PN16

6



PE 100 ELEKTROMUFFE • PE 100 ELEKTROVINKEL

KATALOG 22

Elektromuffe

Elektromuffe til hurtig og enkel svejsning af PE rør og fittings, med fjernbart centerstop til og med $\varnothing 75$ mm.

PE 100 SDR 11/17



7

Varenr.	Beskrivelse	d mm	D mm	L mm	Type svejsning
1036078323043	40 mm PE100	40	55	86	enkelt
1036078323053	50 mm PE100	50	67	98	enkelt
1036078323066	63 mm PE100	63	80	107	enkelt
1036078323078	75 mm PE100	75	97	118	enkelt
1036078323093	90 mm PE100	90	115	150	enkelt
1036078323113	110 mm PE100	110	142	170	enkelt
1036078323128	125 mm PE100	125	160	170	enkelt
1036078323143	140 mm PE100	140	180	171	enkelt
1036078323163	160 mm PE100	160	205	185	enkelt
1036078323183	180 mm PE100	180	230	192	dobbelt
1036078223203	200 mm PE100	200*	250	220	dobbelt
1036078223228	225 mm PE100	225*	277	204	dobbelt
1036078223253	250 mm PE100	250*	310	210	dobbelt
1036078223318	315 mm PE100	315*	390	230	dobbelt
1036078223358	355 mm PE100	355*	445	254	dobbelt

* Bearbejdet af rør

Elektrovinkel 90°

Elektrovinkel til hurtig og enkel svejsning af PE rør og fittings i tre typer: Lille (A), mellem (B), stor (C).

PE 100 SDR 11

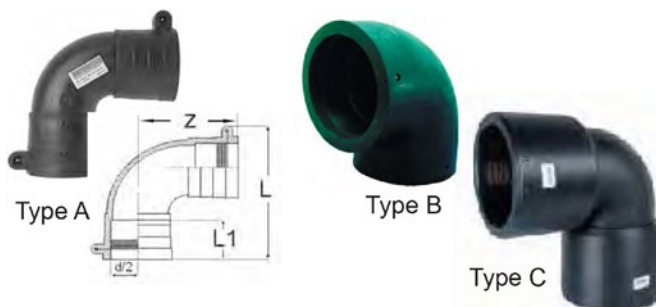

7

Varenr.	Beskrivelse	Type	d mm	L mm	L1 mm	Z mm
1036078306053	50 mm x 90° PE100	A	50	155	51	118
1036078306066	63 mm x 90° PE100	A	63	189	58	126
1036078306078	75 mm x 90° PE100	A	75	211	65	146
1036078306093	90 mm x 90° PE100	A	90	242	70	155
1036078306113	110 mm x 90° PE100	A	110	274	76	176
1036078306128	125 mm x 90° PE100	A	125	297	82	198
1036078306163	160 mm x 90° PE100	B	160	200	85	265
1036078306203	200 mm x 90° PE100	C	200	225	96	282
1036078306228	225 mm x 90° PE100	C	225	250	99	292
1036078306253	250 mm x 90° PE100	C	250	275	105	315



PE 100 ELEKTROVINKEL • PE 100 ELEKTRO TEE

KATALOG 22

Elektrovinkel 45°

Elektrovinkel til hurtig og enkel svejsning af PE rør og fittings i tre typer: Lille (A), mellem (B), stor (C).

PE 100 SDR 11

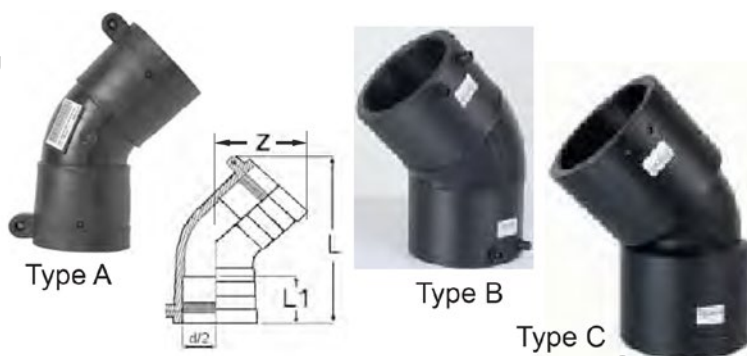

Varenr.	Beskrivelse	Type	d mm	L mm	L1 mm	Z mm
1036078308053	50 mm x 45° PE100	A	50	155	51	118
1036078308078	75 mm x 45° PE100	A	63	189	58	126
1036078308093	90 mm x 45° PE100	A	75	211	65	146
1036078308113	110 mm x 45° PE100	A	90	242	70	155
1036078308128	125 mm x 45° PE100	A	110	274	76	176
1036078308163	160 mm x 45° PE100	A	125	297	82	198
1036078308203	200 mm x 45° PE100	B	160	200	85	265
1036078308228	225 mm x 45° PE100	C	200	225	96	282

Elektro tee

Elektro tee til hurtig og enkel svejsning af PE rør og fittings.

PE 100 SDR 11

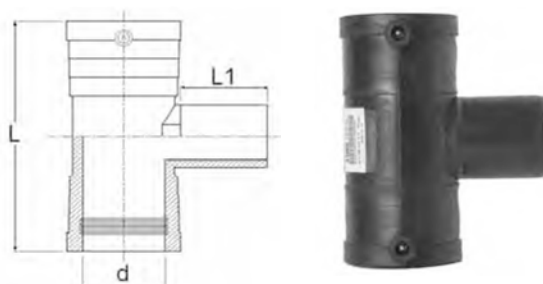

Varenr.	Beskrivelse	d mm	L mm		
1036078312066	63 mm x 90° PE100	63	186		
1036078312078	75 mm x 90° PE100	75	220		
1036078312093	90 mm x 90° PE100	90	255		
1036078312113	110 mm x 90° PE100	110	257		
1036078312128	125 mm x 90° PE100	125	303		
1036078312163	160 mm x 90° PE100	160	340		
1036078312183	180 mm x 90° PE100	180	360		
1036078312203	200 mm x 90° PE100	200	380		
1036078312228	225 mm x 90° PE100	225	400		
1036078312253	250 mm x 90° PE100	250	430		



PE 100 ELEKTRO REDUKTION • PE 100 GEVIND OVERGANG

KATALOG 22

Elektro reduktion

Elektro reduktion til hurtig og enkel svejsning af PE rør og fittings.

PE 100 SDR 11



Varenr.	Beskrivelse	d mm	L mm			7
1036078325062	63 x 50 mm	63-50	152			
1036078325073	75 x 50 mm	75-50	175			
1036078325074	75 x 63 mm	75-63	173			
1036078325087	90 x 50 mm	90-50	190			
1036078325088	90 x 63 mm	90-63	153			
1036078325089	90 x 75 mm	90-75	155			
1036078325107	110 x 63 mm	110-63	209			
1036078325109	110 x 90 mm	110-90	215			
1036078325121	125 x 63 mm	125-63	210			
1036078325123	125 x 90 mm	125-90	205			
1036078325124	125 x 110 mm	125-110	223			
1036078325156	160 x 90 mm	160-90	230			
1036078325157	160 x 110 mm	160-110	230			
1036078325158	160 x 125 mm	160-125	230			
1036078325177	180 x 125 mm	180-125	250			
1036078325198	200 x 160 mm	200-160	250			
1036078325222	225 x 160 mm	225-160	280			
1036078325247	250 x 180 mm	250-180	280			

Gevind overgang - PE spidsende/messing nippel

Gevindovergang med indstøbt messing gevind.

PE 100 SDR 11

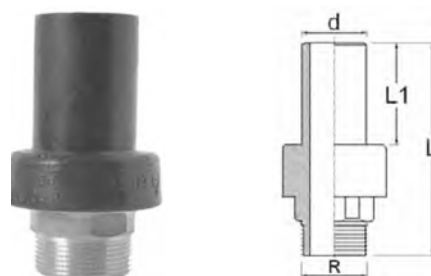

Varenr.	Beskrivelse	d mm	L mm			7
1036074650063	63 mm x 2" nippel	63 x 2"	122			
1036074650075	75 mm x 2½" nippel	75 x 2½"	138			
1036074650090	90 mm x 3" nippel	90 x 3"	153			
1036074650110	110 mm x 4" nippel	110 x 4"	165			

PE 100 GEVIND OVERGANG • PE 100 BØJNING

KATALOG 22

Gevind overgang - PE spidsende/messing muffe

Gevindovergang med indstøbt messing gevind.

PE 100 SDR 11

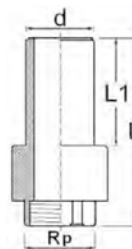

7

Varenr.	Beskrivelse	d mm	L mm			
1036074658063	63 mm x 2" muffe	63 x 2"	147			
1036074658075	75 mm x 2½" muffe	75 x 2½"	158			
1036074658090	90 mm x 3" muffe	90 x 3"	181			
1036074658110	110 mm x 4" muffe	110 x 4"	202			

Bøjning 90° lang

Formet 90° bøjning med radius = 1,5 x d til stuk- eller elektromuffe svejsning.

PE 100 SDR 17

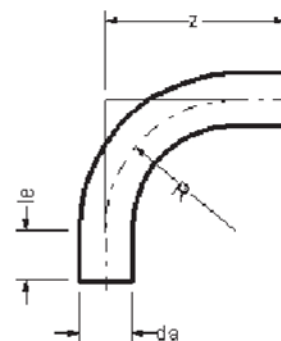

7

Varenr.	Beskrivelse	d mm	Z mm	le mm	R mm	
1036077739063	63 mm x 90° varmbukket	63	195	100	95	
1036077739075	75 mm x 90° varmbukket	75	213	100	113	
1036077739090	90 mm x 90° varmbukket	90	235	100	135	
1036077739110	110 mm x 90° varmbukket	110	315	150	165	
1036077739125	125 mm x 90° varmbukket	125	338	150	188	
1036077739140	140 mm x 90° varmbukket	140	360	150	210	
1036077739160	160 mm x 90° varmbukket	160	420	180	240	
1036077739180	180 mm x 90° varmbukket	180	450	180	270	
1036077739200	200 mm x 90° varmbukket	200	500	200	300	
1036077739225	225 mm x 90° varmbukket	225	538	200	338	
1036077739250	250 mm x 90° varmbukket	250	595	220	375	
1036077739280	280 mm x 90° varmbukket	280	640	220	420	
1036077739315	315 mm x 90° varmbukket	315	723	250	473	

PE 100 BØJNING

KATALOG 22

Bøjning 60° lang

Formet 60° bøjning med radius = 1,5 x d til stuk- eller elektromuffe svejsning.

PE 100 SDR 17

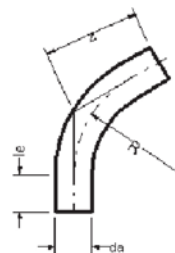

7

Varenr.	Beskrivelse	d mm	Z mm	le mm	R mm
1036077736063	63 mm x 60° varmbukket	63	195	100	113
1036077736075	75 mm x 60° varmbukket	75	213	100	135
1036077736090	90 mm x 60° varmbukket	90	235	100	165
1036077736110	110 mm x 60° varmbukket	110	315	150	188
1036077736125	125 mm x 60° varmbukket	125	338	150	210
1036077736140	140 mm x 60° varmbukket	140	360	150	240
1036077736160	160 mm x 60° varmbukket	160	420	180	270
1036077736180	180 mm x 60° varmbukket	180	450	180	300
1036077736200	200 mm x 60° varmbukket	200	500	200	338
1036077736225	225 mm x 60° varmbukket	225	538	200	375
1036077736250	250 mm x 60° varmbukket	250	595	220	375
1036077736280	280 mm x 60° varmbukket	280	595	220	420
1036077736315	315 mm x 60° varmbukket	315	640	220	473

Bøjning 45° lang

Formet 45° bøjning med radius = 1,5 x d til stuk- eller elektromuffe svejsning.

PE 100 SDR 17

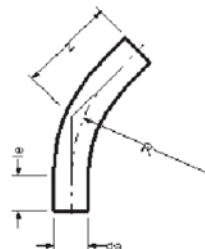

7

Varenr.	Beskrivelse	d mm	Z mm	le mm	R mm
1036077734063	63 mm x 45° varmbukket	63	140	100	95
1036077734075	75 mm x 45° varmbukket	75	147	100	113
1036077734090	90 mm x 45° varmbukket	90	157	100	135
1036077734110	110 mm x 45° varmbukket	110	219	150	165
1036077734125	125 mm x 45° varmbukket	125	229	150	188
1036077734140	140 mm x 45° varmbukket	140	238	150	210
1036077734160	160 mm x 45° varmbukket	160	281	180	240
1036077734180	180 mm x 45° varmbukket	180	293	180	270
1036077734200	200 mm x 45° varmbukket	200	326	200	300
1036077734225	225 mm x 45° varmbukket	225	365	200	338
1036077734250	250 mm x 45° varmbukket	250	440	220	375
1036077734280	280 mm x 45° varmbukket	280	460	220	420
1036077734315	315 mm x 45° varmbukket	315	647	250	473



PE 100 BØJNING

KATALOG 22

Bøjning 30° lang

Formet 30° bøjning med radius = 1,5 x d til stuk- eller elektromuffe svejsning.

PE 100 SDR 17

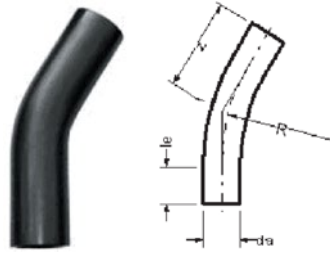

7

Varenr.	Beskrivelse	d mm	Z mm	le mm	R mm
1036077733063	63 mm x 30° varmbukket	63	126	100	95
1036077733075	75 mm x 30° varmbukket	75	130	100	113
1036077733090	90 mm x 30° varmbukket	90	136	100	135
1036077733110	110 mm x 30° varmbukket	110	195	150	165
1036077733125	125 mm x 30° varmbukket	125	201	150	188
1036077733140	140 mm x 30° varmbukket	140	207	150	210
1036077733160	160 mm x 30° varmbukket	160	245	180	240
1036077733180	180 mm x 30° varmbukket	180	253	180	270
1036077733200	200 mm x 30° varmbukket	200	281	200	300
1036077733225	225 mm x 30° varmbukket	225	320	200	338
1036077733250	250 mm x 30° varmbukket	250	400	220	375
1036077733280	280 mm x 30° varmbukket	280	430	220	420
1036077733315	315 mm x 30° varmbukket	315	633	250	473

Bøjning 22° lang

Formet 22° bøjning med radius = 1,5 x d til stuk- eller elektromuffe svejsning.

PE 100 SDR 17

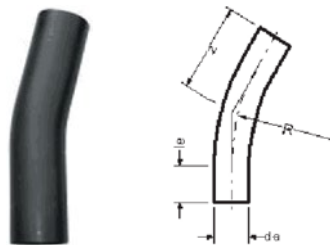

7

Varenr.	Beskrivelse	d mm	Z mm	le mm	R mm
1036077732063	63 mm x 22° varmbukket	63	126	100	95
1036077732075	75 mm x 22° varmbukket	75	130	100	113
1036077732090	90 mm x 22° varmbukket	90	136	100	135
1036077732110	110 mm x 22° varmbukket	110	195	150	165
1036077732125	125 mm x 22° varmbukket	125	201	150	188
1036077732140	140 mm x 22° varmbukket	140	207	150	210
1036077732160	160 mm x 22° varmbukket	160	245	180	240
1036077732180	180 mm x 22° varmbukket	180	253	180	270
1036077732200	200 mm x 22° varmbukket	200	281	200	300
1036077732225	225 mm x 22° varmbukket	225	320	200	338
1036077732250	250 mm x 22° varmbukket	250	400	220	375
1036077732280	280 mm x 22° varmbukket	280	430	220	420
1036077732315	315 mm x 22° varmbukket	315	633	250	473



PE 100 BØJNING

KATALOG 22

Bøjning 11° lang

Formet 11° bøjning med radius = 1,5 x d til stuk- eller elektromuffe svejsning.

PE 100 SDR 17

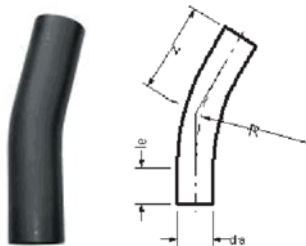

7

Varenr.	Beskrivelse	d mm	Z mm	le mm	R mm
1036077731063	63 mm x 11° varmbukket	63	126	100	95
1036077731075	75 mm x 11° varmbukket	75	130	100	113
1036077731090	90 mm x 11° varmbukket	90	136	100	135
1036077731110	110 mm x 11° varmbukket	110	195	150	165
1036077731125	125 mm x 11° varmbukket	125	201	150	188
1036077731140	140 mm x 11° varmbukket	140	207	150	210
1036077731160	160 mm x 11° varmbukket	160	245	180	240
1036077731180	180 mm x 11° varmbukket	180	253	180	270
1036077731200	200 mm x 11° varmbukket	200	281	200	300
1036077731225	225 mm x 11° varmbukket	225	320	200	338
1036077731250	250 mm x 11° varmbukket	250	400	220	375
1036077731280	280 mm x 11° varmbukket	280	430	220	420
1036077731315	315 mm x 11° varmbukket	315	633	250	473

Støbt bøjning 90° lang

Sprøjtstøbt 90° bøjning med stor radius til stuk- eller elektromuffe svejsning. Radius = d

PE 100 SDR 17



7

Varenr.	Beskrivelse	d mm	Z mm	lB mm
1036077701063	63 mm x 90° støbt	63	130	63
1036077701075	75 mm x 90° støbt	75	152	75
1036077701090	90 mm x 90° støbt	90	168	79
1036077701110	110 mm x 90° støbt	110	193	82
1036077701125	125 mm x 90° støbt	125	216	90
1036077701140	140 mm x 90° støbt	140	232	90
1036077701160	160 mm x 90° støbt	160	258	98
1036077701180	180 mm x 90° støbt	180	290	105
1036077701200	200 mm x 90° støbt	200	317	112
1036077701225	225 mm x 90° støbt	225	350	120
1036077701250	250 mm x 90° støbt	250	380	130
1036077701280	280 mm x 90° støbt	280	430	150
1036077701315	315 mm x 90° støbt	315	470	150



PE 100 VINKEL

KATALOG 22

Støbt vinkel 90° lang

Sprøjtstøbt 90° vinkel til stuk- eller elektromuffe svejsning.

PE 100 SDR 17

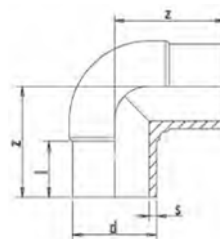

7

Varenr.	Beskrivelse	d mm	Z mm	l mm	
1036077706063	63 mm x 90° støbt	63	95	56	
1036077706075	75 mm x 90° støbt	75	116	72	
1036077706090	90 mm x 90° støbt	90	139	78	
1036077706110	110 mm x 90° støbt	110	158	86	
1036077706125	125 mm x 90° støbt	125	180	104	
1036077706140	140 mm x 90° støbt	140	198	119	
1036077706160	160 mm x 90° støbt	160	210	117	
1036077706180	180 mm x 90° støbt	180	222	116	
1036077706200	200 mm x 90° støbt	200	250	128	
1036077706225	225 mm x 90° støbt	225	269	136	
1036077706250	250 mm x 90° støbt	250	307	180	
1036077706280	280 mm x 90° støbt	280	340	200	
1036077706315	315 mm x 90° støbt	315	370	210	

Støbt vinkel 45° lang

Sprøjtstøbt 45° vinkel til stuk- eller elektromuffe svejsning.

PE 100 SDR 17

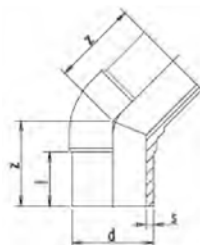

7

Varenr.	Beskrivelse	d mm	Z mm	l mm	
1036077708063	63 mm x 45° støbt	63	82	56	
1036077708075	75 mm x 45° støbt	75	96	75	
1036077708090	90 mm x 45° støbt	90	120	84	
1036077708110	110 mm x 45° støbt	110	129	91	
1036077708125	125 mm x 45° støbt	125	147	101	
1036077708140	140 mm x 45° støbt	140	153	104	
1036077708160	160 mm x 45° støbt	160	169	113	
1036077708180	180 mm x 45° støbt	180	186	120	
1036077708200	200 mm x 45° støbt	200	201	127	
1036077708225	225 mm x 45° støbt	225	218	134	
1036077708250	250 mm x 45° støbt	250	217	155	
1036077708280	280 mm x 45° støbt	280	232	162	
1036077708315	315 mm x 45° støbt	315	251	173	



PE 100 VINKEL

KATALOG 22

Støbt vinkel 30° lang

Sprøjtstøbt 30° vinkel til stuk- eller elektromuffe svejsning.

PE 100 SDR 17

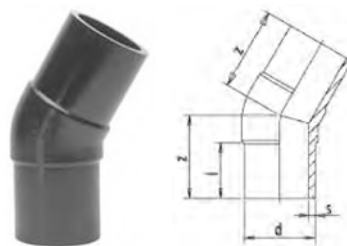

7

Varenr.	Beskrivelse	d mm	Z mm	l mm	
1036077709075	75 mm x 30° støbt	75	108	77	
1036077709090	90 mm x 30° støbt	90	116	85	
1036077709110	110 mm x 30° støbt	110	130	96	
1036077709125	125 mm x 30° støbt	125	143	102	
1036077709140	140 mm x 30° støbt	140	148	110	
1036077709160	160 mm x 30° støbt	160	154	108	
1036077709180	180 mm x 30° støbt	180	160	116	
1036077709200	200 mm x 30° støbt	200	170	122	
1036077709225	225 mm x 30° støbt	225	185	129	

Tee lang

Tee med samme dimension på alle grene, til stuk- eller elektromuffe svejsning.

PE 100 SDR 17

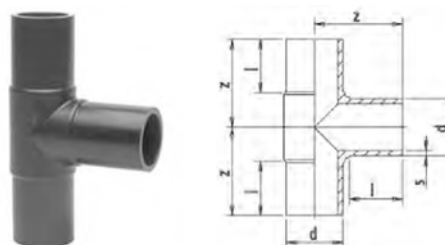

7

Varenr.	Beskrivelse	d mm	Z mm	l mm	
1036077711063	63 mm tee	63	114	70	
1036077711075	75 mm tee	75	120	73	
1036077711090	90 mm tee	90	153	86	
1036077711110	110 mm tee	110	168	95	
1036077711125	125 mm tee	125	177	100	
1036077711140	140 mm tee	140	193	105	
1036077711160	160 mm tee	160	225	124	
1036077711180	180 mm tee	180	233	119	
1036077711200	200 mm tee	200	251	127	
1036077711225	225 mm tee	225	272	138	
1036077711250	250 mm tee	250	314	148	
1036077711280	280 mm tee	280	346	160	
1036077711315	315 mm tee	315	380	170	



PE 100 GRENRØR • PE 100 REDUKTION

KATALOG 22

Grenrør 45° lang

Sprøjtstøbt grenrør uden svejsning og dermed ingen vulst. Til stuk- eller elektromuffe svejsning.

PE 100 SDR 17

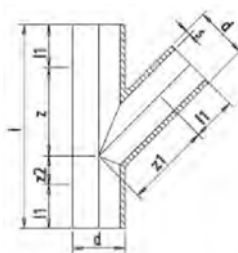

Varenr.	Beskrivelse	d mm	l mm	l1 mm	7
1036077749063	63 mm x 45° støbt	63	245	63	
1036077749075	75 mm x 45° støbt	75	290	74	
1036077749090	90 mm x 45° støbt	90	370	85	
1036077749110	110 mm x 45° støbt	110	400	84	
1036077749125	125 mm x 45° støbt	125	440	105	
1036077749160	160 mm x 45° støbt	160	540	115	
1036077749180	180 mm x 45° støbt	180	575	116	
1036077749200	200 mm x 45° støbt	200	625	122	

Reduktion lang

Centrisk reduktion, til stuk- eller elektromuffe svejsning

PE 100 SDR 17

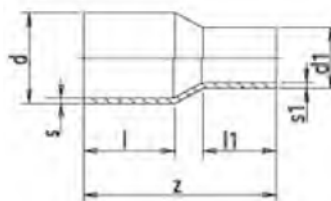

Varenr.	Beskrivelse	d - d1 mm	Z mm	l mm	l1 mm	7
1036077725074	75 x 63 mm	75-63	139	64	43	
1036077725087	90 x 50 mm	90-50	151	73	58	
1036077725088	90 x 63 mm	90-63	148	73	55	
1036077725089	90 x 75 mm	90-75	174	78	72	
1036077725107	110 x 63 mm	110-63	171	84	63	
1036077725108	110 x 75 mm	110-75	183	86	57	
1036077725109	110 x 90 mm	110-90	171	76	68	
1036077725121	125 x 63 mm	125-63	183	87	55	
1036077725122	125 x 75 mm	125-75	195	90	60	
1036077725123	125 x 90 mm	125-90	183	85	69	
1036077725124	125 x 110 mm	125-110	185	88	75	
1036077725137	140 x 90 mm	140-90	220	102	90	
1036077725138	140 x 110 mm	140-110	207	95	90	
1036077725139	140 x 125 mm	140-125	207	95	98	
1036077725156	160 x 90 mm	160-90	225	106	90	
1036077725157	160 x 110 mm	160-110	226	105	93	
1036077725158	160 x 125 mm	160-125	226	105	95	
1036077725159	160 x 140 mm	160-140	220	105	95	



PE 100 REDUKTION

KATALOG 22

Reduktion lang

Centrisk reduktion, til stuk- eller elektromuffe svejsning

PE 100 SDR 17

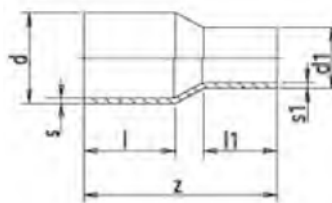

7

Varenr.	Beskrivelse	d - d1 mm	Z mm	l mm	l1 mm
1036077725175	180 x 90 mm	180-90	225	110	90
1036077725176	180 x 110 mm	180-110	230	110	90
1036077725177	180 x 125 mm	180-125	242	112	90
1036077725178	180 x 140 mm	180-140	218	100	83
1036077725179	180 x 160 mm	180-160	220	105	103
1036077725195	200 x 110 mm	200-110	240	110	100
1036077725196	200 x 125 mm	200-125	240	110	100
1036077725197	200 x 140 mm	200-140	240	110	100
1036077725198	200 x 160 mm	200-160	243	110	103
1036077725199	200 x 180 mm	200-180	277	140	125
1036077725219	225 x 110 mm	225-110	277	117	105
1036077725222	225 x 160 mm	225-160	260	120	118
1036077725223	225 x 180 mm	225-180	263	120	115
1036077725224	225 x 200 mm	225-200	260	130	105
1036077725246	250 x 160 mm	250-160	339	138	111
1036077725247	250 x 180 mm	250-180	280	130	105
1036077725248	250 x 200 mm	250-200	337	137	127
1036077725249	250 x 225 mm	250-225	337	137	137
1036077725276	280 x 180 mm	280-180	350	146	119
1036077725277	280 x 200 mm	280-200	350	146	124
1036077725278	280 x 225 mm	280-225	350	146	129
1036077725279	280 x 250 mm	280-250	350	146	134
1036077725312	315 x 225 mm	315-225	320	150	130
1036077725313	315 x 250 mm	315-250	335	153	130
1036077725314	315 x 280 mm	315-280	380	157	148

PE 100 ENDEKAPPE

KATALOG 22

Endekappe

Endekappe til permanent eller midlertidig afprovpning.
Til stuk- eller elektromuffe svejsning.

PE 100 SDR 17

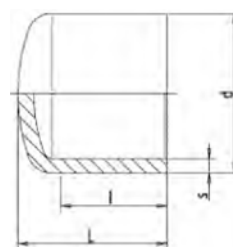

7

Varenr.	Beskrivelse	d mm	L mm	l mm	
103607778063	63 mm endekappe	63	84	67	
103607778075	75 mm endekappe	75	92	73	
103607778090	90 mm endekappe	90	103	80	
103607778110	110 mm endekappe	110	115	95	
103607778125	125 mm endekappe	125	125	110	
103607778140	140 mm endekappe	140	140	121	
103607778160	160 mm endekappe	160	152	134	
103607778180	180 mm endekappe	180	169	140	
103607778200	200 mm endekappe	200	184	160	
103607778225	225 mm endekappe	225	200	152	
103607778250	250 mm endekappe	250	230	162	
103607778280	280 mm endekappe	280	257	167	
103607778315	315 mm endekappe	315	262	170	

Flangehale

Flangehale til løsflange (husk pakning!), til stuk- eller elektromuffe svejsning.

PE 100 SDR 17

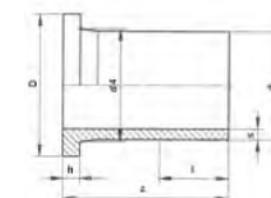

7

Varenr.	Beskrivelse	d mm	Z mm	l mm	h mm
1036077751063	63 mm flangehale	63	105	70	14
1036077751075	75 mm flangehale	75	126	89	16
1036077751090	90 mm flangehale	90	141	103	17
1036077751110	110 mm flangehale	110	161	117	18
1036077751125	125 mm flangehale	125	171	132	18
1036077751140	140 mm flangehale	140	180	100	18
1036077751160	160 mm flangehale	160	180	105	18
1036077751180	180 mm flangehale	180	180	110	20
1036077751200	200 mm flangehale	200	200	120	24
1036077751225	225 mm flangehale	225	200	125	24
1036077751250	250 mm flangehale	250	186	119	25
1036077751280	280 mm flangehale	280	245	156	25
1036077751315	315 mm flangehale	315	215	150	25



PE 100 BØJNING KORT • PE 100 VINKEL KORT

KATALOG 22

Bøjning 90° kort

Sprøjttestøbt 90° bøjning med radius til stuksvejsning.

PE 100 SDR 17

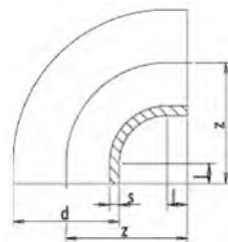

Varenr.	Beskrivelse	d mm	Z mm	l mm	7
1036079111063	63 mm x 90° bøjning kort	63	66	12	
1036079111075	75 mm x 90° bøjning kort	75	87	14	
1036079111090	90 mm x 90° bøjning kort	90	100	15	
1036079111110	110 mm x 90° bøjning kort	110	118	15	
1036079111125	125 mm x 90° bøjning kort	125	138	15	
1036079111140	140 mm x 90° bøjning kort	140	155	20	
1036079111160	160 mm x 90° bøjning kort	160	178	25	
1036079111180	180 mm x 90° bøjning kort	180	195	25	
1036079111200	200 mm x 90° bøjning kort	200	210	20	
1036079111225	225 mm x 90° bøjning kort	225	236	25	
1036079111250	250 mm x 90° bøjning kort	250	279	30	
1036079111280	280 mm x 90° bøjning kort	280	316	40	
1036079111315	315 mm x 90° bøjning kort	315	352	40	

Vinkel 90° kort

Sprøjttestøbt 90° vinkel til stuksvejsning.

PE 100 SDR 17

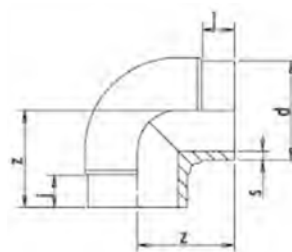

Varenr.	Beskrivelse	d mm	Z mm	l mm	7
1036079116075	75 mm x 90° vinkel kort	75	70	25	
1036079116090	90 mm x 90° vinkel kort	90	91	28	
1036079116110	110 mm x 90° vinkel kort	110	101	34	
1036079116125	125 mm x 90° vinkel kort	125	120	42	
1036079116140	140 mm x 90° vinkel kort	140	125	45	
1036079116160	160 mm x 90° vinkel kort	160	146	50	
1036079116180	180 mm x 90° vinkel kort	180	171	55	
1036079116200	200 mm x 90° vinkel kort	200	188	60	
1036079116225	225 mm x 90° vinkel kort	225	205	65	
1036079116250	250 mm x 90° vinkel kort	250	222	70	
1036079116280	280 mm x 90° vinkel kort	280	259	80	
1036079116315	315 mm x 90° vinkel kort	315	295	90	



PE 100 VINKEL KORT • PE 100 TEE KORT

KATALOG 22

Vinkel 45° kort

Sprøjtstøbt 45° vinkel til stuksvejsning.

PE 100 SDR 17

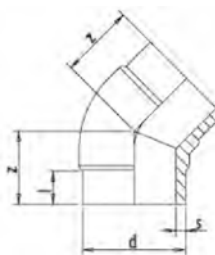

7

Varenr.	Beskrivelse	d mm	Z mm	l mm	
1036079113075	75 mm x 45° vinkel kort	75	68	25	
1036079113090	90 mm x 45° vinkel kort	90	66	28	
1036079113110	110 mm x 45° vinkel kort	110	79	34	
1036079113140	140 mm x 45° vinkel kort	140	97	45	
1036079113160	160 mm x 45° vinkel kort	160	108	50	
1036079113180	180 mm x 45° vinkel kort	180	112	55	
1036079113200	200 mm x 45° vinkel kort	200	125	60	
1036079113225	225 mm x 45° vinkel kort	225	131	65	
1036079113250	250 mm x 45° vinkel kort	250	117	70	
1036079113280	280 mm x 45° vinkel kort	280	139	80	
1036079113315	315 mm x 45° vinkel kort	315	148	90	

Tee kort

Tee til stuksvejsning

PE 100 SDR 17

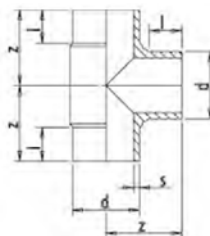

7

Varenr.	Beskrivelse	d mm	Z mm	l mm	
1036079134063	63 mm x tee kort	63	63	25	
1036079134075	75 mm x tee kort	75	75	25	
1036079134090	90 mm x tee kort	90	98	30	
1036079134110	110 mm x tee kort	110	128	40	
1036079134125	125 mm x tee kort	125	127	50	
1036079134140	140 mm x tee kort	140	153	50	
1036079134160	160 mm x tee kort	160	160	60	
1036079134180	180 mm x tee kort	180	212	60	
1036079134200	200 mm x tee kort	200	212	65	
1036079134225	225 mm x tee kort	225	215	85	
1036079134250	250 mm x tee kort	250	224	118	
1036079134280	280 mm x tee kort	280	262	131	
1036079134315	315 mm x tee kort	315	280	143	



PE 100 REDUKTION KORT

KATALOG 22

Reduktion kort

Centrisk reduktion til stuksvejsning.

PE 100 SDR 17

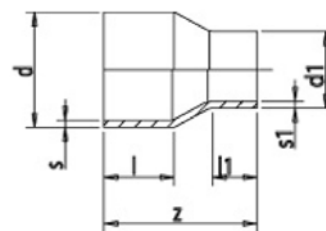

7

Varenr.	Beskrivelse	d - d1 mm	Z mm	l mm	l1 mm	
1036079148061	63 x 50 mm red. kort	63-50	54	25	20	
1036079148062	75 x 40 mm red. kort	75-40	70	29	22	
1036079148073	75 x 50 mm red. kort	75-50	71	28	23	
1036079148074	75 x 63 mm red. kort	75-63	70	29	31	
1036079148087	90 x 50 mm red. kort	90-50	73	26	22	
1036079148088	90 x 63 mm red. kort	90-63	71	29	24	
1036079148089	90 x 75 mm red. kort	90-75	80	33	33	
1036079148106	110 x 50 mm red. kort	110-50	90	33	29	
1036079148107	110 x 63 mm red. kort	110-63	91	42	23	
1036079148108	110 x 75 mm red. kort	110-75	90	34	35	
1036079148109	110 x 90 mm red. kort	110-90	88	40	28	
1036079148121	125 x 63 mm red. kort	125-63	100	40	34	
1036079148122	125 x 75 mm red. kort	125-75	103	48	31	
1036079148123	125 x 90 mm red. kort	125-90	100	38	30	
1036079148124	125 x 110 mm red. kort	125-110	100	40	48	
1036079148136	140 x 75 mm red. kort	140-75	110	49	37	
1036079148137	140 x 90 mm red. kort	140-90	126	45	28	
1036079148138	140 x 110 mm red. kort	140-110	126	45	34	
1036079148139	140 x 125 mm red. kort	140-125	128	45	42	
1036079148156	160 x 90 mm red. kort	160-90	120	53	37	
1036079148157	160 x 110 mm red. kort	160-110	125	50	39	
1036079148158	160 x 125 mm red. kort	160-125	120	54	45	
1036079148159	160 x 140 mm red. kort	160-140	98	44	43	
1036079148175	180 x 90 mm red. kort	180-90	130	59	37	
1036079148176	180 x 110 mm red. kort	180-110	130	60	40	
1036079148177	180 x 125 mm red. kort	180-125	152	62	42	
1036079148178	180 x 140 mm red. kort	180-140	130	59	46	
1036079148179	180 x 160 mm red. kort	180-160	131	60	55	
1036079148196	200 x 125 mm red. kort	200-125	160	60	45	
1036079148197	200 x 140 mm red. kort	200-140	140	60	48	
1036079148198	200 x 160 mm red. kort	200-160	140	60	54	
1036079148199	200 x 180 mm red. kort	200-180	140	60	61	
1036079148219	225 x 110 mm red. kort	225-110	190	68	67	
1036079148221	225 x 140 mm red. kort	225-140	160	65	57	
1036079148222	225 x 160 mm red. kort	225-160	190	65	50	
1036079148223	225 x 180 mm red. kort	225-180	190	65	55	
1036079148224	225 x 200 mm red. kort	225-200	160	71	71	



PE 100 REDUKTION KORT • PP BELAGT STÅLFLANGE

KATALOG 22

Reduktion kort

Centrisk reduktion til stuksvejsning.

PE 100 SDR 17

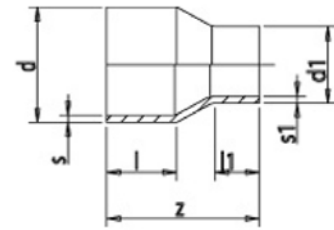

Varenr.	Beskrivelse	d - d1 mm	Z mm	l mm	l1 mm	7
1036079148246	250 x 160 mm red. kort	250-160	210	70	50	
1036079148247	250 x 180 mm red. kort	250-180	200	70	55	
1036079148248	250 x 200 mm red. kort	250-200	200	70	60	
1036079148249	250 x 225 mm red. kort	250-225	200	70	65	
1036079148277	280 x 200 mm red. kort	280-200	220	80	60	
1036079148278	280 x 225 mm red. kort	280-225	220	80	65	
1036079148279	280 x 250 mm red. kort	280-250	220	80	70	
1036079148311	315 x 200 mm red. kort	315-200	230	95	85	
1036079148312	315 x 225 mm red. kort	315-225	245	90	65	
1036079148313	315 x 250 mm red. kort	315-250	245	90	70	
1036079148314	315 x 280 mm red. kort	315-280	245	90	80	

PP belagt stålflange

Centrisk reduktion til stuksvejsning.

PE 100 SDR 17

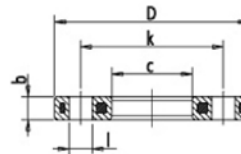

Varenr.	Beskrivelse	PN	b mm	k mm	bolte	Nm	7
1036075761040	DN 32 / 40 mm	16	16	100	4xM16	25	
1036075761050	DN 40 / 50 mm	16	18	110	4xM16	35	
1036075761063	DN 50 / 63 mm	16	18	125	4xM16	35	
1036075761075	DN 65 / 75 mm	16	18	145	4xM16	40	
1036075761090	DN 80 / 90 mm	16	18	160	8xM16	40	
1036075761110	DN 100 / 110 mm	16	18	180	8xM16	40	
1036075761125	DN 100 / 125 mm	16	18	180	8xM16	45	
1036075761140	DN 125 / 140 mm	16	24	210	8xM16	50	
1036075761160	DN 150 / 160 mm	16	24	240	8xM20	60	
1036075761180	DN 150 / 180 mm	16	24	240	8xM20	60	
1036075761200	DN 200 / 200 mm	10	24	295	8xM20	70	
1036075761225	DN 200 / 225 mm	10	24	295	8xM20	70	
1036075761250	DN 250 / 250 mm	10	31	350	12xM20	100	
1036075761280	DN 250 / 280 mm	10	34	350	12xM20	100	
1036075761315	DN 300 / 315 mm	10	34	400	12xM20	110	